

## Isolating transformer DS0107

Three-phase isolating transformers for the supply of three-phase loads in medical locations

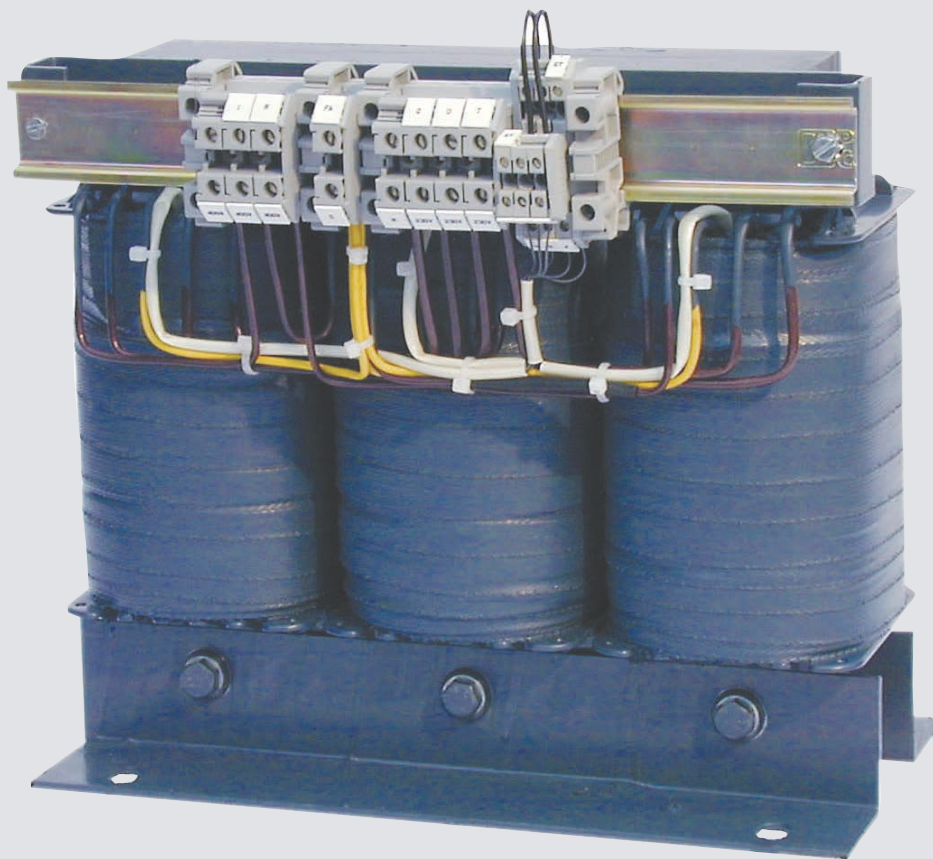

# Isolating transformer DS0107

Three-phase isolating transformers for the supply of three-phase loads in medical locations

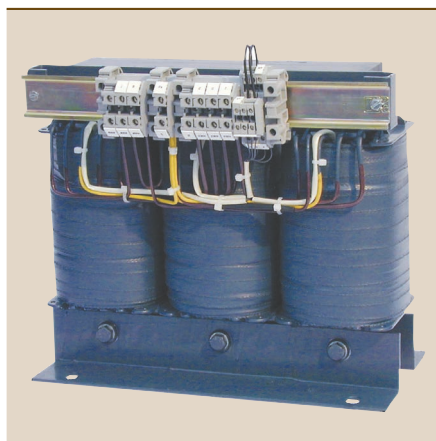

DS0107

## Device features

- Built-in temperature sensors acc. to DIN 44081 (120 °C)
- Screen winding with brought-out insulated connection terminal
- Insulated mounting angles
- Degree of protection, IP00 (open design)
- Degree of protection, IP23 (with enclosure)
- Protection class I
- Protection class II (option: encapsulated version)
- Reinforced insulation
- Classification of insulation ta40/B
- Connections: screw terminals
- Noise level < 35 dB (A) (no-load and nominal load)
- Vector group: Yyn O

## Approvals



## Application and description

The transformers of the DS0107 series have reinforced insulation and comply with the requirements of IEC 61558-1/DIN EN 61558-1 (VDE 0570-1) and IEC 61558-2-15 DIN EN 61558-2-15 (VDE 0570-2-15).

In addition, the transformers comply with the requirements of IEC 60364-7-710/DIN VDE 0100-710 (VDE 0100-710) for IT systems in medical locations. The windings are galvanically isolated. In order to minimize electrical interferences, an electrostatic screen is installed between the primary and secondary winding the lead out of which is connected to an insulated terminal for connection to the equipotential bonding.

The fixing angles are isolated from the transformer core in order to guarantee an isolated installation to comply with the requirements of DIN VDE 0100-710 (VDE 0100-710): 2002-11, para 710.512.1.6.2).

The transformers are available for horizontal and vertical installation. Protection against corrosion is guaranteed by a complete resin impregnation.

The transformers are designed for use in dry locations. Transformers of the SK2 series are completely encapsulated and fulfil the requirements of protection class II.

## Frequency/ratings

The transformers are designed for rated frequencies of 50...60 Hz. The values specified in the chapter "Technical data" refer to a maximum ambient temperature of 40 °C and a rated frequency of 50 Hz.

## Temperature rise

Free air circulation must be ensured. An ambient temperature exceeding 40 °C will reduce the rated power. For temperature monitoring, a PTC thermistor is placed on each transformer leg and the leads are connected to the terminals.

## Enclosure

Appropriate steel sheet enclosures, degree of protection IP 23, are available for all standard types of isolating transformers.

## Standards

DS0710 isolating transformers comply with the device standards and the regulations for installation: DIN EN 61558-1 (VDE 570-1), IEC 61558-1, DIN VDE 0100-710 (VDE 0100-710), DIN EN 61558-2-15 (VDE 0570-2-15), IEC 61558-2-15, IEC 60364-7-710.

## Note:

- According to DIN VDE 0100-710 (VDE 0100-710): 2002-11, para. 710.512.1.6.2, single-phase transformers shall be used for the erection of medical IT systems.
- The transformers of the DS0107 series are not suitable for the erection and installation of medical IT systems.

## Nameplate

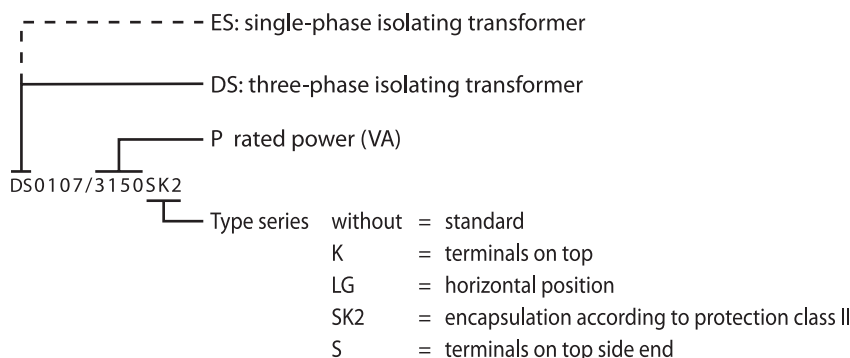

**Dimension diagram/type of construction**

Standard – Dimension B is the depth incl. terminals

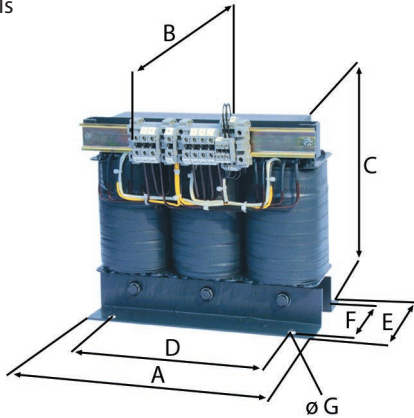

SK2 series

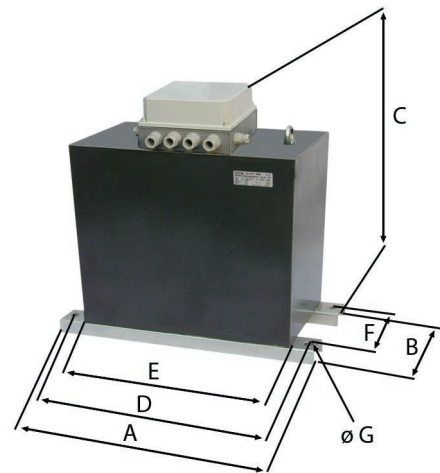

K series

All other dimensions correspond to the standard dimensions.

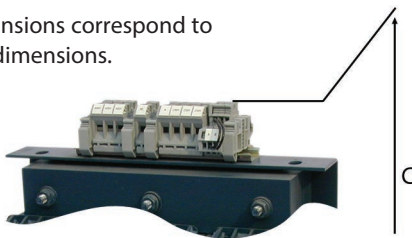

LG series

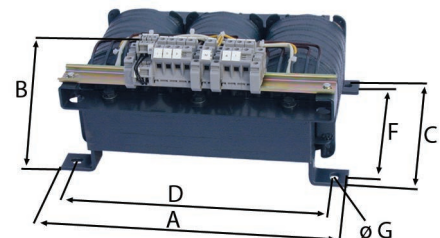

**Ordering information**

	Dimensions (mm)							Cu weight (kg)	Weight (kg)	Type	Art. No.
	A	B	C	D	E	F	G				
Standard	300	200	270	240	160	130	11	16	34	DS107/2000	B 924 694
	360	210	325	310	170	135	11	28	63	DS107/3150	B 924 106
	360	225	325	310	185	150	11	29	70	DS107/4000	B 924 121
	360	240	325	310	200	165	11	31	77	DS107/5000	B 924 112
	420	230	370	370	200	160	11	48	97	DS107/6300	B 924 107
	420	245	370	370	215	175	11	51	107	DS107/8000	B 924 628
	420	260	370	370	230	190	11	59	130	DS107/10000	B 924 672
K series	300		310	240	162	130	11	16	34	DS107/2000K	B 924 687
	360		360	310	170	135	11	28	63	DS107/3150K	B 924 688
	360		360	310	185	150	11	29	70	DS107/4000K	B 924 689
	360		360	310	200	165	11	31	77	DS107/5000K	B 924 690
	420		420	370	200	160	11	48	97	DS107/6300K	B 924 691
	420		420	370	215	175	11	51	107	DS107/8000K	B 924 692
	420		420	370	230	190	11	59	130	DS107/10000K	B 924 693
LG series	330	195	265	298		200	7	16	34	DS107/2000LG	B 924 695
	394	198	310	358		240	9	28	63	DS107/3150LG	B 924 658
	394	214	310	358		240	9	29	70	DS107/4000LG	B 924 659
	394	228	310	358		240	9	31	77	DS107/5000LG	B 924 660
	452	212	360	408		280	12	48	97	DS107/6300LG	B 924 661
	452	227	360	408		280	12	51	107	DS107/8000LG	B 924 662
	452	250	360	408		280	12	59	130	DS107/10000LG	B 924 679
SK2 series	410	190	400	380	330	125	11	16	49	DS107/2000SK2	B 924 696
	520	190	450	490	390	135	11	28	75	DS107/3150SK2	B 924 122
	520	190	450	490	390	135	11	29	80	DS107/4000SK2	B 924 123
	520	200	450	490	390	150	11	31	86	DS107/5000SK2	B 924 124
	520	200	500	490	450	150	11	48	107	DS107/6300SK2	B 924 125
	520	215	500	490	450	175	11	51	130	DS107/8000SK2	B 924 126
	520	230	500	490	450	175	11	59	155	DS107/10000SK2	B 924 678

**Wiring diagram**

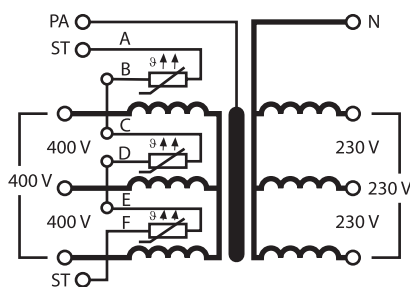

**Terminal diagram**

Standard,  
K series,  
LG series

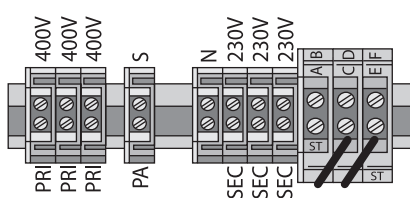

SK2 series

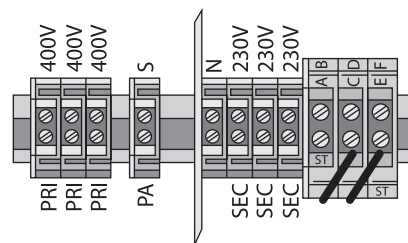

**Connection properties**

Type	Input terminals flexible/rigid	Screen winding flexible/rigid	Control terminals flexible/rigid	Output terminals flexible/rigid
DS0107/2000	10/16 mm <sup>2</sup>	10/16 mm <sup>2</sup>	2.5/4 mm <sup>2</sup>	10/16 mm <sup>2</sup>
DS0107/3150	10/16 mm <sup>2</sup>	10/16 mm <sup>2</sup>	2.5/4 mm <sup>2</sup>	10/16 mm <sup>2</sup>
DS0107/4000	10/16 mm <sup>2</sup>	10/16 mm <sup>2</sup>	2.5/4 mm <sup>2</sup>	10/16 mm <sup>2</sup>
DS0107/5000	10/16 mm <sup>2</sup>	10/16 mm <sup>2</sup>	2.5/4 mm <sup>2</sup>	10/16 mm <sup>2</sup>
DS0107/6300	10/16 mm <sup>2</sup>	10/16 mm <sup>2</sup>	2.5/4 mm <sup>2</sup>	16/25 mm <sup>2</sup>
DS0107/8000	10/16 mm <sup>2</sup>	10/16 mm <sup>2</sup>	2.5/4 mm <sup>2</sup>	16/25 mm <sup>2</sup>
DS0107/10000	16/25 mm <sup>2</sup>	16/25 mm <sup>2</sup>	2.5/4 mm <sup>2</sup>	16/25 mm <sup>2</sup>

**Technical data**

Type	DS0107/2000	DS0107/3150	DS0107/4000	DS0107/5000	DS0107/6300	DS0107/8000	DS0107/10000
Insulation classification	t <sub>a</sub> 40/B	t <sub>a</sub> 40/B	t <sub>a</sub> 40/B	t <sub>a</sub> 40/B	t <sub>a</sub> 40/B	t <sub>a</sub> 40/B	t <sub>a</sub> 40/B
Degree of protection	IP00	IP00	IP00	IP00	IP00	IP00	IP00
Protection class	I/II*	I/II*	I/II*	I/II*	I/II*	I/II*	I/II*

**Power/voltages/currents**

Rated power	2000 VA	3150 VA	4000 VA	5000 VA	6300 VA	8000 VA	10000 VA
Rated frequency	50...60 Hz	50...60 Hz	50...60 Hz	50...60 Hz	50...60 Hz	50...60 Hz	50...60 Hz
Rated input voltage	3AC 400 V	3AC 400 V	3AC 400 V	3AC 400 V	3AC 400 V	3AC 400 V	3AC 400 V
Rated input current	3 A	4.9 A	6.1 A	7.7 A	9.8 A	12.2 A	15.6 A
Rated output voltage	3NAC 230 V	3NAC 230 V	3NAC 230 V	3NAC 230 V	3NAC 230 V	3NAC 230 V	3NAC 230 V
Rated output current	5 A	7.9 A	10 A	12.6 A	15.8 A	20.1 A	25.2 A
Inrush current <i>I<sub>E</sub></i>	< 12 x <i>I<sub>n</sub></i>	< 12 x <i>I<sub>n</sub></i>	< 12 x <i>I<sub>n</sub></i>	< 12 x <i>I<sub>n</sub></i>	< 12 x <i>I<sub>n</sub></i>	< 12 x <i>I<sub>n</sub></i>	< 12 x <i>I<sub>n</sub></i>
Leakage current	≤ 0.5 mA	≤ 0.5 mA	≤ 0.5 mA	≤ 0.5 mA	≤ 0.5 mA	≤ 0.5 mA	≤ 0.5 mA
No-load input current <i>i<sub>0</sub></i>	≤ 3.0 %	≤ 3.0 %	≤ 3.0 %	≤ 3.0 %	≤ 3.0 %	≤ 3.0 %	≤ 3.0 %
No-load output voltage <i>u<sub>0</sub></i>	≤ 232 V	≤ 235 V	≤ 234 V	≤ 236 V	≤ 236 V	≤ 235 V	≤ 235 V
Short-circuit voltage <i>u<sub>k</sub></i>	≤ 2.9 %	≤ 2.9 %	≤ 2.8 %	≤ 3 %	≤ 2.8 %	≤ 2.8 %	≤ 2.5 %

**Environmental conditions**

Ambient temperature	≤ 40 °C	≤ 40 °C	≤ 40 °C	≤ 40 °C	≤ 40 °C	≤ 40 °C	≤ 40 °C
No-load temperature rise	≤ 25 °C	≤ 21 °C	≤ 24 °C	≤ 28 °C	≤ 24 °C	≤ 27 °C	≤ 32 °C
Full-load temperature rise	≤ 50 °C	≤ 50 °C	≤ 53 °C	≤ 67 °C	≤ 60 °C	≤ 72 °C	≤ 75 °C
Noise level (no load and full load)	≤ 35 dB(A)	≤ 35 dB(A)	≤ 35 dB(A)	≤ 35 dB(A)	≤ 35 dB(A)	≤ 35 dB(A)	≤ 35 dB(A)

**Other**

Recommended fuse when used in accordance with DIN VDE 0100-710	10 A gL/gG	16 A gL/gG	20 A gL/gG	20 A gL/gG	25 A gL/gG	35 A gL/gG	35 A gL/gG
Induction	1.0 T	0.8 T	0.86 T	0.8 T	0.8 T	0.8 T	0.82 T
<i>R<sub>primary</sub></i>	1.12 Ω	0.7 Ω	0.42 Ω	0.38 Ω	0.33 Ω	0.26 Ω	0.13 Ω
<i>R<sub>secondary</sub></i>	0.27 Ω	0.17 Ω	0.13 Ω	0.12 Ω	0.07 Ω	0.055 Ω	0.05 Ω
FE loss (iron loss)	45 W	51 W	70 W	75 W	80 W	96 W	120 W
Cu loss (copper loss)	60 W	105 W	115 W	170 W	200 W	255 W	270 W
Efficiency	95 %	96 %	95 %	95 %	96 %	96 %	96 %

\* Option: completely encapsulated version

**Isolating transformer enclosure**

**ESDS0107-1**

Sheet steel enclosure in vertical position for three-phase transformers DS0107/2000 to DS0107/5000.

**ESDS0107-2**

Sheet steel enclosure in vertical position for three-phase transformers DS0107/6300 to DS0107/10000.

**Enclosure**

- Sheet steel, varnished in RAL 7032
- Degree of protection IP 23
- Bore holes for cable entry
- The enclosures of our transformers (standard version), transformer sizes of 2...10 kVA, are provided with fixing holes intended for easy retrofitting at any time.

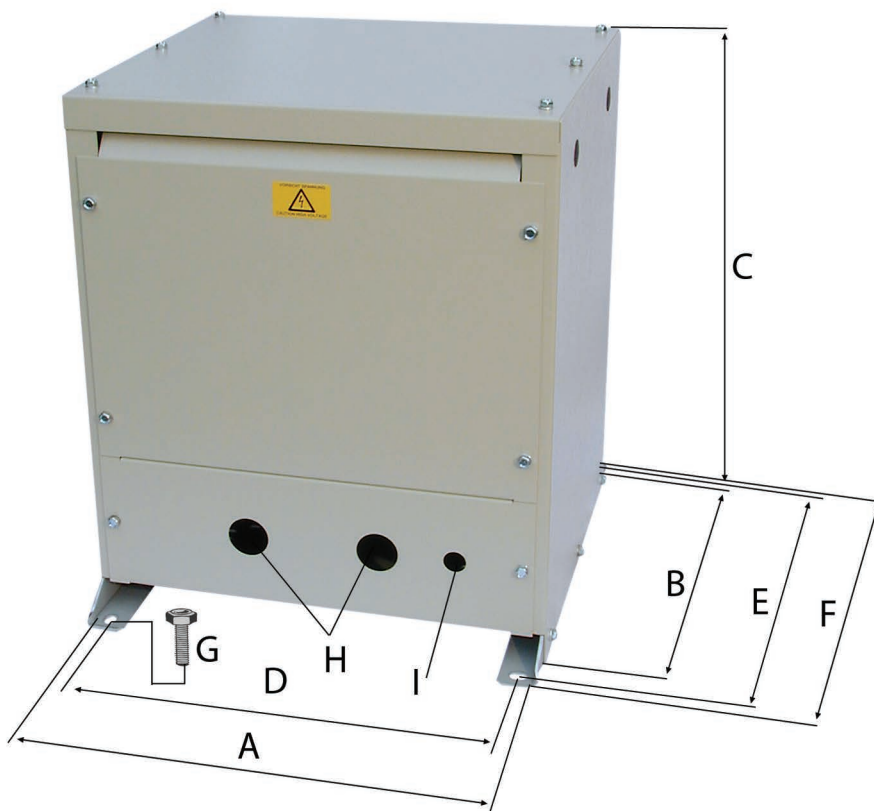

**Ordering information enclosure**

Dimensions (mm)									Suitable for the following device types	Weight (kg)	Type	Art. No.
A	B	C	D	E	F	G	H	I				
430	380	490	385	420	450	M10	ø 29	ø 21	DS0107/2000 bis DS0107/5000	16	ESDS0107-1	B 924 673
600	420	490	555	460	490	M10	ø 36	ø 16	DS0107/6300 bis DS0107/10000	23	ESDS0107-2	B 924 674



**Bender GmbH & Co. KG**

P.O. Box 1161 • 35301 Gruenberg • Germany  
Londorfer Strasse 65 • 35305 Gruenberg • Germany  
Tel.: +49 6401 807-0 • Fax: +49 6401 807-259  
E-Mail: [info@bender.de](mailto:info@bender.de) • [www.bender.de](http://www.bender.de)



**BENDER Group**