



AC/DC



BENDER
CONNECT

ISOMETER® isoGEN413R-1

Insulation monitoring device

for unearthed 3(N)AC, AC and DC systems in generator applications

according to DIN VDE 0100-551



Image similar

Table of contents

1	General information.....	4
1.1	How to use the manual.....	4
1.2	Indication of important instructions and information.....	4
1.3	Service and Support.....	4
1.4	Training courses and seminars.....	4
1.5	Delivery conditions.....	4
1.6	Inspection, transport and storage.....	5
1.7	Warranty and liability.....	5
1.8	Disposal of Bender devices.....	5
1.9	Safety.....	6
2	Product description.....	7
2.1	Intended use.....	7
2.1.1	Device-specific information.....	7
2.2	Scope of delivery.....	8
2.3	Device features.....	8
2.4	Functions.....	8
2.4.1	Insulation fault R_F	8
2.4.2	Insulation fault location.....	9
2.4.3	System leakage capacitance C_e	9
2.4.4	Connection monitoring L1/L2.....	9
2.4.5	Connection monitoring FE1/FE2.....	10
2.4.6	Test (manual).....	10
2.4.7	Device error.....	10
2.4.8	Message assignments for the alarm relay.....	10
2.4.9	Delay times t_b , t , t_{on} , t_{ae} , t_{an} and t_{off}	11
2.4.10	Reset device to factory settings.....	12
2.4.11	Fault memory.....	12
2.4.12	Start with alarm.....	12
2.4.13	Reset.....	12
3	Mounting.....	13
3.1	Dimension Diagram.....	13
3.2	Mounting of the device.....	14
3.3	Sealable transparent cover.....	14
4	Connection.....	15
4.1	Connections overview.....	15

4.2	Wiring diagram.....	16
4.3	Supply voltage U_S	17
4.4	RS-485 interface.....	17
4.5	Relay.....	18
5	Operation and setting on the device.....	19
5.1	Control panel.....	19
5.2	Status LED.....	20
5.3	Alarm LEDs.....	20
5.4	Measured value display LEDs.....	21
5.5	Setting the response value R_{an1} for the prewarning.....	21
5.6	Setting the response value R_{an2} for the main alarm.....	21
5.7	T/R button.....	22
5.7.1	Function RESET.....	22
5.7.2	Function TEST.....	22
5.7.3	Function NFC.....	22
5.7.4	Function ADDR.....	23
5.7.5	Function PROTECT.....	23
6	Modbus settings.....	25
6.1	Overview.....	25
6.2	Data types.....	25
6.3	Read and write accesses.....	25
6.4	Register areas.....	25
6.5	Register table isoGEN413R-1.....	26
7	Error – Cause – Error correction.....	31
8	Maintenance.....	32
9	Technical data.....	33
9.1	Tabular data.....	33
9.2	Standards and certificates.....	37
9.3	Ordering information.....	37
9.4	Document revision history.....	37

1 General information

1.1 How to use the manual



ADVICE

This manual is intended for qualified personnel working in electrical engineering and electronics! Part of the device documentation in addition to this manual is the enclosed supplement "Safety instructions for Bender products".



ADVICE

Read the operating manual before mounting, connecting and commissioning the device. Keep the manual within easy reach for future reference.

1.2 Indication of important instructions and information



DANGER

Indicates a high risk of danger that will result in death or serious injury if not avoided.



WARNING

Indicates a medium risk of danger that can lead to death or serious injury if not avoided.



CAUTION

Indicates a low-level risk that can result in minor or moderate injury or damage to property if not avoided.



ADVICE

Indicates important facts that do not result in immediate injuries. They can lead to malfunctions if the device is handled incorrectly.



Information can help to optimise the use of the product.

1.3 Service and Support

Information and contact details about customer service, repair service or field service for Bender devices are available on the following website: <https://www.bender.de/en/service-support>.

1.4 Training courses and seminars

Regular face-to-face or online seminars for customers and other interested parties:

<https://www.bender.de/en/know-how/seminars>

1.5 Delivery conditions

The conditions of sale and delivery set out by Bender GmbH & Co. KG apply. These can be obtained in printed or electronic format.

1.6 Inspection, transport and storage

Check the shipping and device packaging for transport damage and scope of delivery. In the event of complaints, the company must be notified immediately. Please use the contact form at the following address: <https://www.bender.de/en/service-support/take-back-of-old-devices/>.

When storing the devices, observe the information under Environment / EMC in the technical data.

1.7 Warranty and liability

Warranty and liability claims for personal injury and property damage are excluded in the case of:

- improper use of the device
- incorrect mounting, commissioning, operation and maintenance of the device
- Failure to observe the instructions in this operating manual regarding transport, commissioning, operation and maintenance of the device
- unauthorised changes to the device made by parties other than the manufacturer
- non-observance of technical data
- Repairs carried out incorrectly
- the use of accessories or spare parts that are not provided, approved or recommended by the manufacturer
- Catastrophes caused by external influences and force majeure
- Mounting and installation with device combinations not approved or recommended by the manufacturer

This operating manual and the enclosed safety instructions must be observed by all persons working with the device. Furthermore, the rules and regulations that apply for accident prevention at the place of use must be observed.

1.8 Disposal of Bender devices

Abide by the national regulations and laws governing the disposal of this device.



Bender GmbH & Co. KG is registered in the waste from electrical and electronic equipment (WEEE) register under the WEEE number: DE 43 124 402. For more information on the disposal of Bender devices, refer to <https://www.bender.de/en/service-support/take-back-of-old-devices/>

1.9 Safety

If the device is used outside the Federal Republic of Germany, the applicable local standards and regulations must be complied with. In Europe, the European standard EN 50110 applies.



DANGER

Risk of fatal injury due to electric shock!

Touching live parts of the system carries the risk of:

- *Electrocution due to electric shock*
- *Damage to the electrical installation*
- *Destruction of the device*

Before installing the device and before working on its connections, make sure that the installation is de-energised.

Observe the rules for working on electrical systems.

ATTENTION

Device damage possible due to insulation and voltage tests!

If the insulation monitoring device is not disconnected from the IT system before performing insulation or voltage tests, the tests may fail and the device may be damaged.

- *Disconnect the insulation monitoring device from the IT system for the duration of the test.*

2 Product description

2.1 Intended use

The isoGEN413R-1 is used in unearthed systems to monitor the insulation fault R_F and to locate the R_F fault (positive or negative conductor) in DC systems. In addition to the limit value comparison, functions for connection monitoring, detection internal faults and the exceeding of the maximum permissible leakage capacitance C_e are available.

The device is designed to monitor IT systems supplied by generators in accordance with DIN VDE 0100-551.

The DC components existing in AC/DC systems can have an influence on the response behaviour if an insulation fault occurs downstream of rectifiers with an electrolytic capacitor.

The separate supply voltage of the isoGEN413R-1 also enables monitoring of a de-energised system.

Any other use than that described in this manual is regarded as improper.

Do not make any unauthorised changes to the device. Only use spare parts and optional accessories sold or recommended by the manufacturer.

Intended use also includes

- the observation of all information in the manual and
- compliance with test intervals.

To comply with the applicable standards, the device must be configured for the local system and operating conditions. Observe the operating limits specified in the technical data.

2.1.1 Device-specific information

i

IT systems with several ISOMETER®s

Only one ISOMETER® may be connected in a galvanically connected system. In IT systems that are interconnected via tie switches, ISOMETER®s that are not required must be disconnected from the IT system.

Do not connect insulation monitoring devices in parallel, e.g. when coupling systems.

Prevent measurement errors!

In galvanically coupled DC circuits, an insulation fault can only be detected correctly if a minimum load current of > 10 mA flows through the rectifiers.

Unspecified frequency range

Continuous insulation monitoring is not possible in low frequency ranges (see technical data). For IT systems with frequency components above the specified frequency range, there is no influence on the insulation monitoring.

Observe the permissible mains leakage capacitance

The mains leakage capacitance C_e affects the response threshold and response time.

- Refer to the Technical Data for the permissible mains leakage capacitance C_e .

2.2 Scope of delivery

Included in delivery:

- ISOMETER® isoGEN413R-1
- Connector kit for push-in terminals
- Quick-start guide DE/EN
- Safety instructions

2.3 Device features

- Monitoring of the insulation resistance for unearthed 3(N)AC, AC and DC systems with galvanically connected rectifiers
- Automatic adaptation to the system leakage capacitance up to 5 μF
- Response time $\leq 1 \text{ s}$ at $C_e = 1 \mu\text{F}$ and $R_{an} = 100 \Omega/\text{V}$ (in accordance to DIN VDE 0100-551)
- Automatic and manual device self test with connection monitoring
- Two separately adjustable response value ranges (5...250 k Ω)¹
- Alarm output via LEDs (AL1, AL2) and alarm relay
- Selectable n/c or n/o relay operation¹
- Selectable start-up delay, response delay and delay on release¹
- Fault memory activatable ¹
- RS-485 interface with Modbus RTU protocol
- NFC interface

¹ via Bender Connect app or Modbus RTU

2.4 Functions

The isoGEN413R-1 is an insulation monitoring device in accordance with IEC 61557-8 for IT systems.

The measured value R_F as well as all messages and alarms are displayed via LEDs and can be read out via Modbus RTU and NFC. The messages and alarms are also output via the relay **K1**, depending on the message assignments that can be set via the interfaces.

2.4.1 Insulation fault R_F

Measurement Range and Output

The insulation fault R_F is measured in the range of 1 k Ω to 10 M Ω in unearthed 3(N)AC, AC, DC and DC superimposed AC systems. The value can be read from the Modbus register **[1000] Insulation resistance**. The device displays the value via the value display LEDs in the range of 1 k Ω to 1 M Ω .

With each update of the measured value R_F , the Modbus register **[3002] Measured value update counter** is incremented.

Limit Value Comparison and Alarm Messages

The two response values R_{an1} and R_{an2} are available for the limit value comparison.

- If R_F falls below R_{an1} or R_{an2} for the duration t_{on} , the corresponding alarm **AL1** or **AL2** is activated.
- If R_F exceeds R_{an1} or R_{an2} plus hysteresis for the duration t_{off} , the alarms **AL1** or **AL2** are cleared, provided the fault memory is deactivated.

Setting the Response Values

For instructions, refer to:

- “Setting the response value R_{an1} for the prewarning”, page 21
- “Setting the response value R_{an2} for the main alarm”, page 21

Alarm Assignment to Relay

The alarms **AL1** and **AL2** can be assigned to the relay **K1** via the Modbus register

[32103] Alarm assignment Alarm 1 and **[32104] Alarm assignment Alarm 2**.

Influence on Response Behaviour

 *The DC components existing in AC/DC systems can influence the response behaviour if an insulation fault occurs downstream of rectifiers.*

2.4.2 Insulation fault location

If the isoGEN413R-1 detects a DC offset to earth of at least 10 V in the monitored system, the insulation fault location **R%** is assigned to the positive or negative conductor with + or – **100 %**. This can occur when monitoring a DC system or an AC system with an insulation fault in the DC link. In the case of symmetrical faults or below 5 V, **R%** is set to 0. The value of **R%** can be read via the Modbus register **[3001] Insulation fault location**.

2.4.3 System leakage capacitance C_e

If the measured value cannot be recorded due to excessive system leakage capacitance C_e or excessive disturbances in the system, the message **max. C_e /fault** appears and is indicated by the LEDs. The message can be assigned to relay **K1** via the Modbus register **[32107] Alarm assignment max. C_e /fault**.

2.4.4 Connection monitoring L1/L2

Function

The connection monitoring **L1/L2** continuously checks the low-resistance connection R_{LL} between the terminals **L1** and **L2** of the isoGEN413R-1 via the monitored system. If the resistance is too high, the alarm **L1/L2** is triggered, indicated by the LEDs. The R_{LL} value can be read via Modbus register [2003].

Relay assignment

The alarm can be assigned to via the Modbus register **[32106] Alarm assignment L1/L2**.

Alarm clearance

If the fault memory is not enabled, the alarm is automatically cleared once the fault has been resolved.

Disabling

Connection monitoring can be disabled via the register **[33400] Connection monitoring L1/L2**.

2.4.5 Connection monitoring FE1/FE2

Function

The connection monitoring **FE1/FE2** continuously checks the low-resistance connection R_{FE} of the isoGEN413R-1 between the terminals **FE1** and **FE2**. If the resistance is $> 5 \text{ k}\Omega$ (readable via Modbus register [2002]), **Alarm FE1/FE2** (Modbus register [2000]) is triggered and indicated by the LEDs. The monitoring function cannot be deactivated.

Relay assignment

The alarm can be assigned to relay **K1** via Modbus register **[32105] Alarm assignment FE1/FE2**.

Alarm clearance

If the fault memory is disabled, the alarm is deleted once the connection fault has been resolved.

2.4.6 Test (manual)

Function

When the **T/R** button is operated (3...6 s) or the Modbus function *Test* is executed, the device simulates an insulation fault $< 1 \text{ k}\Omega$. All LEDs light up. After the test has ended automatically, the message status before the test is restored (even if the fault memory is activated).

Relay assignment

Via the Modbus register **[32101] Test message assignment**, this message can be assigned to relay K1.



The user must perform the self-test cyclically, depending on the operator's specifications.

2.4.7 Device error

In the event of a device error, the status LED changes color to red or yellow. The error code can be queried via Modbus register 58000...58013.

2.4.8 Message assignments for the alarm relay

The following messages can be assigned to the alarm relay:

Function	State	Modbus register	Description
Relay mode	n/o principle n/c principle	32100	<ul style="list-style-type: none"> n/c n/c operation of the contacts. In fault-free condition, the relay is energised. n/o n/o operation of the contacts. In fault-free condition, the relay is de-energised.
Test	on off	32101	This parameter determines whether the relay is actuated during a test.
Main alarm	on off	32104	The relay switches when R_F falls below the response value R_{an2} (AL2).

Function	State	Modbus register	Description
Prewarning	on off	32103	The relay switches when R_F falls below the response value R_{an1} (AL1).
Device error	on off	32102	The relay switches if a device error exists.
Connection fault system	on off	32106	The relay switches when there is a system connection fault.
Connection fault functional earth	on off	32105	The relay switches when there is a connection fault to earth.
Leakage capacitance exceeded	on off	32107	The relay switches when the permissible system leakage capacitance C_e is exceeded or when the measured value acquisition is faulty.

2.4.9 Delay times t_{br} , t , t_{on} , t_{ae} , t_{an} and t_{off}

The times described below delay the output of alarms via LEDs, relays and Modbus RTU. They can be set from Modbus register 33300.

Recovery time t_b

The recovery time is the time the device needs to be ready for measurement after connecting the supply voltage U_S .

Start-up delay t

After switching on the supply voltage U_S , the start of the measuring function is delayed by the set time t (0...1800 s, Modbus register 33302) in addition to the recovery time t_b .

Response delay t_{on}

The response delay t_{on} is set uniformly for the messages **AL1** and **AL2** using Modbus register 33300, whereby each alarm message has its own timer for t_{on} .

An alarm is only signalled if the limit value of the respective measured value is violated continuously for the duration of t_{on} . Each recurring violation of the limit value within the time t_{on} restarts the response delay.

Operating time t_{ae}

The operating time t_{ae} is determined, among others, by the factor $R_f \times C_e$.

Total response time t_{an}

Total response time t_{an} = Operating time t_{ae} + Response delay t_{on}

Delay on release t_{off}

The delay time t_{off} can be set uniformly for the messages **AL1** and **AL2** in Modbus register 33301, whereby each alarm message has its own timer for t_{off} .

An alarm is signalled until the limit value (including hysteresis) of the respective measured value is no longer violated for the duration of t_{off} .

Each time the limit value violation ends within the time t_{off} , the delay on release t_{off} is restarted.
Delay on release t_{off} is only active when the fault memory is inactive.

2.4.10 Reset device to factory settings

Prerequisite

Parameter write protection is disabled.

Function

This function in the Modbus registers 60000...60003 offers two options:

- **Factory setting without interface parameters**
resets all device parameters to the factory settings, except the Modbus interface parameters.
- **Factory setting with interface parameters**
resets all device parameters to the factory settings.

2.4.11 Fault memory

The fault memory can be enabled or disabled. When enabled, alarm messages remain active until a reset is performed and no error is present.

Modbus register: [33201]

Factory setting: disabled

2.4.12 Start with alarm

Start with alarm makes the device start with the measured value $R_F = 1 \text{ k}\Omega$ when it is restarted. The resulting alarm messages **AL1** and **AL2** are retained until the measured value R_F is above the respective limit values. The limit value hysteresis and the fault memory for the respective alarm are not active during this start phase.

Modbus register: [33200]

Factory setting: disabled

2.4.13 Reset

Function

During a reset, limit value comparisons are performed without hysteresis only at the threshold value. Regardless of the fault memory setting, alarm messages from measured values within the hysteresis can be cleared.

Performing a Reset

To perform a reset:

- Execute Modbus function 7 on registers [60000]...[60003].
- Or press the **T/R** button for 1...3 seconds.

3 Mounting



DANGER

Risk of fatal injury due to electric shock!

Touching live parts of the system carries the risk of:

- *Risk of electrocution due to electric shock*
- *Damage to the electrical installation*
- *Destruction of the device*

Before installing the device and before working on its connections, make sure that the installation has been de-energised. The rules for working on electrical systems must be observed.



Only skilled persons are permitted to carry out the work necessary to install, put into service and run a device or system.

3.1 Dimension Diagram

Pluggable push-in terminals

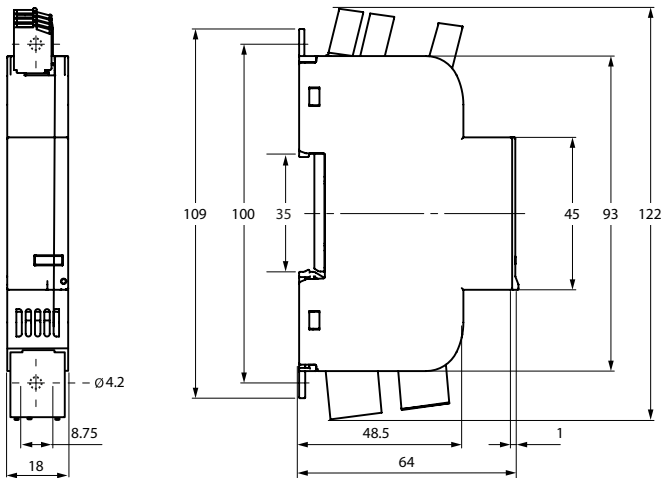

Dimensions in mm

3.2 Mounting of the device

DIN rail mounting

Mounting

Dismounting

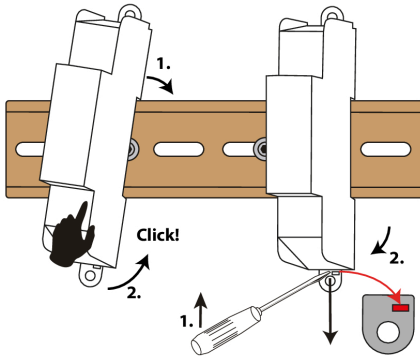

Screw mounting

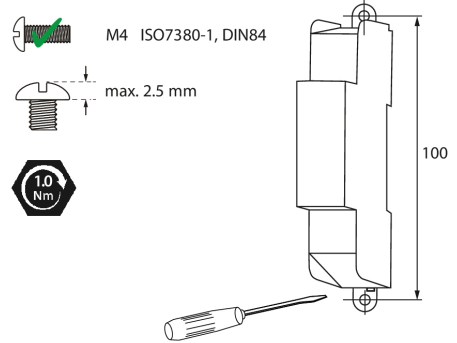

3.3 Sealable transparent cover

The transparent cover prevents settings on the device from being changed. Hook the two hooks on the cover around the top of the enclosure and press the bottom edge around the bottom of the enclosure.

Position of the transparent cover (yellow)

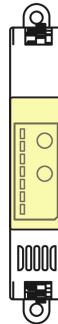

Dimensions in mm (H × W × D): 49 × 18 × 3

4 Connection

4.1 Connections overview

Notes

ATTENTION

An excessive supply voltage can destroy the device.

Apply the correct supply voltage:

- $U_s = DC\ 12 \dots 48\ V$



ADVICE

Only plug or unplug the terminals when they are de-energised.



This product is designed to ensure protective separation between the primary and secondary circuits. The voltage supply must be SELV or PELV (IEC 61140).

Connections top

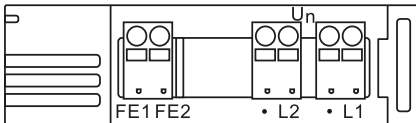

Figure 4-1: isoGEN413R-1 top

Terminal	Connection
FE1, FE2	Functional Earth
L1, L2	Monitored system
•	Not in use

Connections bottom

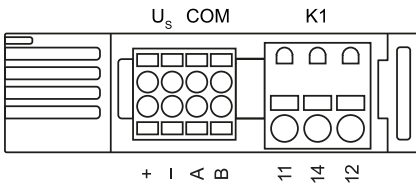
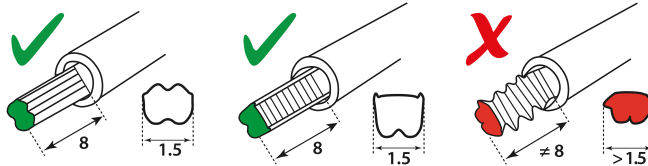

Figure 4-2: isoGEN413R-1 bottom

Terminal	Connection
+, -	Supply voltage DC 12...48 V
A, B	RS-485 interface
11, 14, 12	Relay

Select a suitable crimping tool

- The crimping tool must
 - not compress the ferrule beyond the permissible width, and
 - not create pronounced external indentations on the ferrule.
- For conductor cross-sections from 0.75 mm², use a crimping tool such as **CRIMPFOX 6**, **Weidmüller PZ6** or **Weidmüller PZ6/5**.



4.3 Supply voltage U_S

isoGEN413R-1

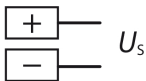

$U_S = \text{DC } 12 \dots 48 \text{ V}$



ADVICE

When looping the supply voltage U_S through the terminal, ensure that the maximum contact rating specified in the technical data is not exceeded.



ADVICE

If the device is supplied from an unearthed system, equip both lines with a back-up fuse.

4.4 RS-485 interface

Description

The RS-485 interface is galvanically isolated from the device electronics. It serves as a transmission medium for various protocols. It can be used to connect compatible devices to an RS-485 network. The specifications for the RS-485 interface are included in the technical data.

Connection

Use daisy chain structure

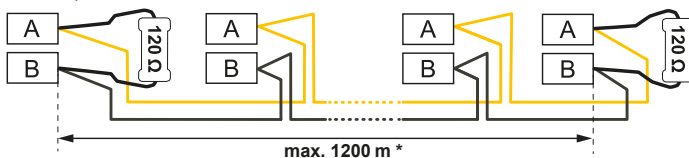

* The length of the bus cable depends on the number of devices, the transmission protocol, the cables used, and interference affecting the system. The following table provides guide values.

Cable length depending on the baud rate (empirical values)

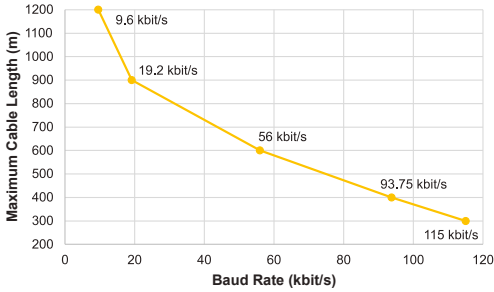

Examples of RS-485 line structures

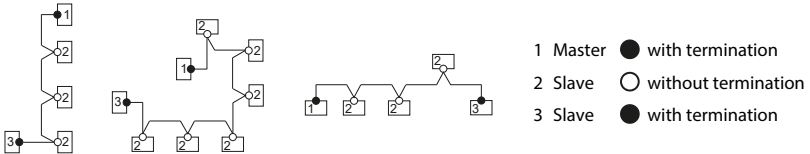

ADVICE

For a stable RS-485 network, please note:

- Schedule the first and last devices in the line.
- Assign each device address uniquely.
- Please refer to the technical data for information on the RS-485 interface.

4.5 Relay

The terminals 11-14-12 are outputs of the relay K1.



ADVICE

Caution! High contact currents can damage the hard gold plating of the relay contacts. Damaged contacts then prevent the relay from switching at low contact currents with low resistance.

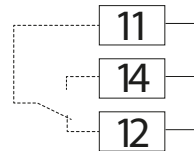

ADVICE

For safety reasons, we recommend operating the relay in n/c mode and using Modbus RTU to evaluate the alarm messages.

5 Operation and setting on the device

5.1 Control panel

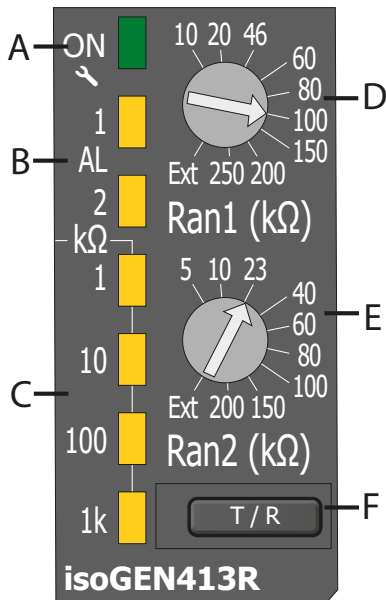

Control panel	
A	Status LED ON: Operating modes
B	Alarm LEDs: AL1 / AL2
C	Value display LEDs: 1, 10, 100, 1k kΩ (1k = 1000 kΩ = 1 MΩ)
D	Detent potentiometer 1: Response value prewarning R_{an1}
E	Detent potentiometer 2: Response value main alarm R_{an2}
F	T/R button: Reset/Test/NFC/Addressing/Write protection

i To confirm a new detent potentiometer position, the new position is output for a few seconds as a binary code (1 = left stop, 10 = Ext) on the value display LEDs. The 1k LED is the least significant bit (LSB).

5.2 Status LED

Multicoloured display of various operating modes.



LED	Operating mode
GREEN	START PHASE Device booting after start NORMAL OPERATION Device in fault-free state
YELLOW flashing with LED value indicator	CONNECTION FAULT <ul style="list-style-type: none"> Leakage capacitance C_g exceeded: LED "10" flashes Connection fault system (L1/L2): LED "100" flashes Connection fault functional earth (FE1/FE2): LED "1k" flashes
RED	DEVICE ERROR Restart or replacement of the device required
BLUE + GREEN flashing	NFC ACTIVE
VIOLET flashing	Activate/deactivate write protection for Modbus registers.

5.3 Alarm LEDs

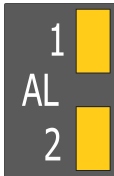

LED	Operation state
AL1	PREWARNING Lights up continuously when the prewarning threshold R_{an1} is undershot.
AL2	MAIN ALARM Lights up continuously when the main alarm threshold R_{an2} is undershot.

5.4 Measured value display LEDs

Measured value display of the insulation resistance.

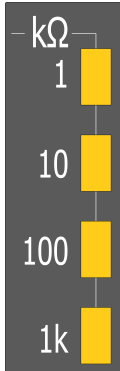

LED	Operation state
1	Lights up continuously: measured value $\leq 1 \text{ k}\Omega$.
10	<ul style="list-style-type: none"> Lights up continuously: measured value $\leq 10 \text{ k}\Omega$ Flashes in sync with the yellow status LED: leakage capacity C_e exceeded
100	<ul style="list-style-type: none"> Lights up continuously: measured value $\leq 100 \text{ k}\Omega$ Flashes in sync with the yellow status LED: connection error in the system.
1k	<ul style="list-style-type: none"> Lights up continuously: measured value $\leq 1 \text{ M}\Omega$ Flashes in sync with the yellow status LED: connection error to earth.

5.5 Setting the response value R_{an1} for the prewarning

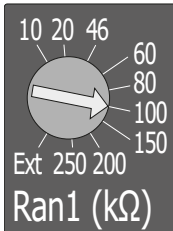

The response value R_{an1} can be manually set to the scale values using the detent potentiometer and read from the Modbus register **[33000] Response value Ran1**.

The response value via Modbus register **[33000] Response value Ran1** can only be changed in potentiometer position **Ext**.

The last response value R_{an1} saved via the interface can be read from the Modbus register **[3008] Response value Ran1_ext**. It is transferred to the response value R_{an1} when the potentiometer is changed to the **Ext** position.

5.6 Setting the response value R_{an2} for the main alarm

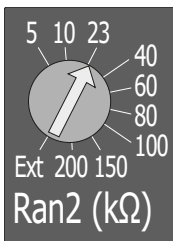

The response value R_{an2} can be manually set to the scale values using the detent potentiometer and read from the Modbus register **[33001] Response value Ran2**.

The response value via Modbus register **[33001] Response value Ran2** can only be changed in potentiometer position **Ext**.

The last response value R_{an2} saved via the interface can be read from the Modbus register **[3009] Response value Ran2_ext**. It is transferred to the response value R_{an2} when the potentiometer is changed to position **Ext**.

5.7 T/R button

The T/R button activates different operating modes depending on how long it is pressed.



Mode	Operating time	Status LED
RESET	1...3 s	flashes yellow
TEST	3...6 s	flashes red
NFC	6...10 s	flashes blue
ADDR	10...15 s	flashes green
PROTECT	20...25 s	flashes violet

Overview

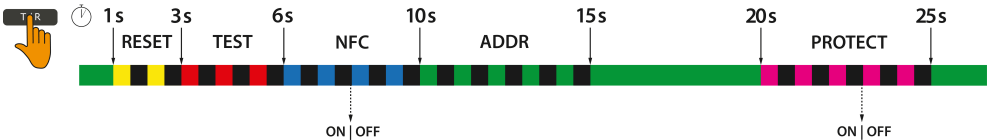

5.7.1 Function RESET

The function **RESET** on the button resets stored alarm states and deactivates the limit hysteresis for this moment.

5.7.2 Function TEST

The function **TEST** simulates an alarm status for 5 seconds. During this period, the device has the following states:

- Display of the alarm value via the LEDs and the interface.
- The test status can be read out via the interface (Modbus register [3000]):
 - 0 = no test
 - 1 = internal test (triggered via T/R button)
 - 2 = external test (triggered via Modbus RTU)
- For the duration of the test t_{on} and t_{off} are set to 0 s.

5.7.3 Function NFC

Press the **T/R** button for 6...10 seconds to activate or deactivate the NFC interface.

The NFC interface deactivates automatically after 5 minutes of inactivity.

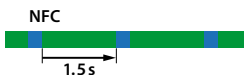

Status indication of normal operation with the NFC interface activated

5.7.4 Function ADDR

Description

The function **ADDR** switches the device to address setting mode for the RS-485 address. The channel indication LEDs and the status LED indicate the device's address. The digits are represented using BCD code.

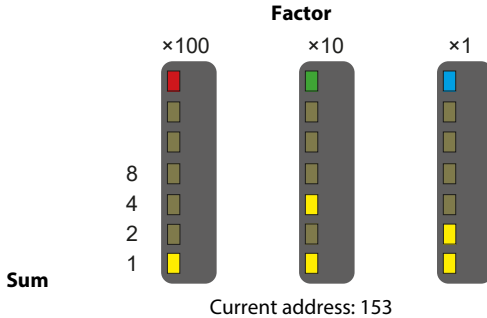

Addresses can only be entered within the valid address range. When there is no input for a period of 5 minutes, the device automatically exits the address setting mode. The device then uses the currently set RS-485 address.

Enter address

How to enter an address:

1. Press and hold the **T/R** button until status LED flashes green (10... 15 s).
– After the **T/R** button is released, the status LED lights red.
2. Set HUNDREDS digit. Press **T/R** button briefly until the desired value appears. Press and hold **T/R** button once (> 2 s) to confirm.
– After the **T/R** button is released, the status LED lights green.
3. Set TENS digit. Press **T/R** button briefly until the desired value appears. Press and hold **T/R** button once (> 2 s) to confirm.
– After the **T/R** button is released, the status LED lights blue.
4. Set UNITS digit. Press **T/R** button briefly until the desired value appears. Press and hold **T/R** button once (> 2 s) to confirm.
5. To exit the address setting mode, press and hold **T/R** button once (2 s).
– After the **T/R** button is released, the status LED lights green.

5.7.5 Function PROTECT

Description

The **PROTECT** function enables or disables write protection for the Modbus registers of the parameters.

Modbus register: [32007]

Factory setting: disabled

Enabling write protection via the Modbus register

You can only enable write protection via the Modbus register, not disable it.

Enabling or disabling write protection via the T/R button

Press the **T/R** button for at least 20 s; then release it while the LED flashes violet (5 s).

6 Modbus settings

6.1 Overview

Description of the Modbus registers

The following function codes are supported:

- Holding register for reading out values (Read Holding Register; function code 0x03)
- Register for device configuration (Write Multiple Registers; function code 0x10)

For a complete Modbus protocol specification, visit www.modbus.org.

6.2 Data types

Float	IEEE754 32-bit (single precision floating point number)
Int16	Signed 16-bit integer
Int32	Signed 32-bit integer
UInt16	Unsigned 16-bit integer
UInt32	Unsigned 32-bit integer
String UTF8	ASCII character string

6.3 Read and write accesses

RO	READ ONLY (read access only)
RW	READ / WRITE (read and write access)
WO	WRITE ONLY (write access only)

6.4 Register areas

Range	Start address	End address
Device information	0	99
Alarm and measured values	999	1999
Monitoring functions	2000	2999
Status information	3000	3999
Modbus RTU parameters	32000	32099
Relay parameters	32100	32199
Response value parameters	33000	33099
Alarm behaviour	33200	33299
Time behaviour	33300	33399
Monitoring functions	33400	33499
Device error codes	58000	58999
Control commands interfaces	59000	59999

Range	Start address	End address
Control commands	60000	60004

6.5 Register table isoGEN413R-1

Address (dec)	Register name	Data type	Bytes	Mode	Value / Unit / Comment	Factory setting
Device information (0...99)						
0	Device name	String UTF8	32	RO	isoGEN413R-1	N/A
16	Article number	String UTF8	32	RO	B81674000	N/A
32	Serial number	String UTF8	32	RO	10 digits e.g.: 2002123456	N/A
48	Manufacturer	String UTF8	32	RO	Bender	N/A
64	Application D number	UInt16	2	RO	772	N/A
65	Application version number Vx.xx	UInt16	2	RO	xxx	N/A
66	Application build number	UInt16	2	RO		N/A
67	Boot loader D number	UInt16	2	RO	705	N/A
68	Bootloader version number Vx.xx	UInt16	2	RO	xxx	N/A
69	Boot loader build number	UInt16	2	RO		N/A
70	Device status	UInt16	2	RO	Bit 0 (LSB): NFC - 0 = disabled, 1 = enabled Bit 1: pot R_{an1} - 0 != ext, 1 = ext Bit 2: pot R_{an2} - 0 != ext, 1 = ext Bit 3...15: 0 (reserved)	N/A
Alarm and measured values (999...1999)						
999	Number of active alarms	UInt16	2	RO	0...7	N/A
1000	Insulation resistance R_F	UInt16	2	RO	0...10000 [k Ω]	N/A
1001	Alarm-1	UInt16	2	RO	0 = No alarm 2 = Alarm, measured value below R_{an1}	N/A
1002	Alarm-2	UInt16	2	RO	0 = No alarm 2 = Alarm, measured value below R_{an2}	N/A
1003	Measuring range status R_F	UInt16	2	RO	0 = " " within measuring range 1 k Ω ...10 M Ω 1 = "<" below measuring range 2 = ">" measuring range exceeded	N/A
Monitoring functions (2000...2999)						
2000	Alarm-FE1/FE2	UInt16	2	RO	0 = No alarm 2 = Alarm, FE1/FE2 connection faulty	N/A
2001	Alarm-L1/L2	UInt16	2	RO	0 = No alarm 2 = Alarm, L1/L2 connection faulty	N/A
2002	R_{FE}	UInt16	2	RO	0...1000 [k Ω]; Resistance between terminals FE1 and FE2	N/A
2003	R_{LL}	UInt16	2	RO	0...1000 [k Ω]; Resistance between terminals L1 and L2	N/A

Address (dec)	Register name	Data type	Bytes	Mode	Value / Unit / Comment	Factory setting
Status information (3000...3999)						
3000	Test status	UInt16	2	RO	0 = No active test 1 = Internal test (triggered on the device) 2 = External test (triggered remotely)	N/A
3001	Insulation fault location	Int16	2	RO	0 = Insulation fault cannot be located 100 = Insulation fault mainly at L1(+) -100 = Insulation fault mainly at L2(-)	N/A
3002	Measured value update counter	UInt32	4	RO	0...2 ³²	N/A
3008	Response value R_{an1_ext}	UInt16	2	RO	10...250 [kΩ], the last response value stored via the interface	46 kΩ
3009	Response value R_{an2_ext}	UInt16	2	RO	5...200 [kΩ] the last response value stored via the interface	23 kΩ
Modbus RTU parameters (32000...32099)						
32000	Device address	UInt16	2	RW	1...247	Last 2 digits of the serial number + 100
32001	Baud rate	UInt32	4	RW	9600, 19200, 38400, 57600, 115200	19200
32003	Parity	UInt16	2	RW	1 = even 2 = odd 3 = none	1
32004	Stop bits	UInt16	2	RW	1 = 1 2 = 2 3 = automatic	3
32006	Update permission	UInt16	2	RW	0 = SW update via Modbus RTU not permitted 1 = SW update via Modbus RTU permitted	0
32007	Write protection	UInt16	2	RW	1 = Write protection disabled 2 = Write protection enabled NOTE: All parameters are write-protected. Disabling only via T/R button.	1
Relais (32100...32199)						
32100	Relay mode	UInt16	2	RW	1 = n/o principle 2 = n/c principle	2
32101	Alarm assignment test	UInt16	2	RW	0 = disabled 1 = enabled	1
32102	Alarm assignment device error	UInt16	2	RW	0 = disabled 1 = enabled	1
32103	Alarm assignment prewarning R_{an1}	UInt16	2	RW	0 = disabled 1 = enabled	0
32104	Alarm assignment main alarm R_{an2}	UInt16	2	RW	0 = disabled 1 = enabled	1
32105	Alarm assignment connection fault FE1/FE2	UInt16	2	RW	0 = disabled 1 = enabled	1
32106	Alarm assignment connection fault L1/L2	UInt16	2	RW	0 = disabled 1 = enabled	1
32107	Alarm assignment Max. C_g / fault	UInt16	2	RW	0 = disabled 1 = enabled	1

Address (dec)	Register name	Data type	Bytes	Mode	Value / Unit / Comment	Factory setting
Response values (33000...33099)						
33000	Response value prewarning R_{an1}	Uint16	2	RW	10... 250 [kΩ], step size 1 kΩ, writing enabled when R_{an1} potentiometer is set to <i>Ext</i>	46 kΩ
33001	Response value main alarm R_{an2}	Uint16	2	RW	5...200 [kΩ], step size 1 kΩ, writing enabled when R_{an2} potentiometer is set to <i>Ext</i>	23 kΩ
Alarm behaviour (33200...33299)						
33200	Start with alarm	Uint16	2	RW	0 = disabled 1 = enabled	0
33201	Fault memory	Uint16	2	RW	0 = disabled 1 = enabled	0
Time behaviour (33300...33399)						
33300	Response delay t_{on}	Uint16	2	RW	0...1800 [s], Step size 1 s	0
33301	Delay on release t_{off}	Uint16	2	RW	0...1800 [s], Step size 1 s	0
33302	Start-up delay t	Uint16	2	RW	0...1800 [s], Step size 1 s	0
Monitoring functions (33400...33499)						
33400	Connection monitoring L1/L2	Uint16	2	RW	0 = disabled 1 = enabled	1
Device error codes (58000...58999)						
58000	Number of device errors	Uint16	2	RO	Number of active device errors	N/A
58001	FE1/FE2 connection fault	Uint16	2	RO	Error code = 30	N/A
58002	L1/L2 connection fault	Uint16	2	RO	Error code = 40	N/A
58003	Reserved	Uint16	2	RO	Error code = 0	N/A
58004	Reserved	Uint16	2	RO	Error code = 0	N/A
58005	Error: Measurement equipment timeout (C_e too high or interference in the system/measurement equipment)	Uint16	2	RO	Error code = 405	N/A
58006	Error: Calibration	Uint16	2	RO	Error code = 600	N/A
58007	Error: Write protection	Uint16	2	RO	Error code = 631	N/A
58008	Error: Read protection	Uint16	2	RO	Error code = 651	N/A
58009	Error: measurement equipment HW	Uint16	2	RO	Error code = 820	N/A
58010	Error: internal voltage 24 V	Uint16	2	RO	Error code = 843	N/A
58011	Error: internal voltage 3.5 V	Uint16	2	RO	Error code = 846	N/A
58012	Error: internal voltage V_{ref} 3.3 V	Uint16	2	RO	Error code = 849	N/A
58013	Reserved	Uint16	2	RO	Error code = 0	N/A

Address (dec)	Register name	Data type	Bytes	Mode	Value / Unit / Comment	Factory setting
Control commands interfaces (59000...59999)						
59000	NFC	Uint16	2	RW	0 = disabled 1 = enabled (automatic disabling when no communication for 5 min)	0
59001	Relay test	Uint16	2	RW	0 = Disable relay (automatic return to normal operating mode after 60 s) 1 = Enable relay (automatic return to normal operating mode after 60 s) 2 = Relay test inactive (normal operating mode)	2
Control commands (60000)						
60000	Function selection	Uint16	2	WO	Function selection register to control the function of the following registers. Only specified values are permitted. 2 = Find device 4 = Reset to factory settings / Reset parameters 6 = Test 7 = Reset	N/A
Function 2: Find device						
60000	Function selection	Uint16	2	WO	2 → Selection of the function <i>Find device</i>	N/A
60001	Pattern value part 1	Uint16	2	WO	61918 → Safety pattern must be written for the function to be executed	N/A
60002	Pattern value part 2	Uint16	2	WO	0 → Safety pattern must be written for the function to be executed.	N/A
60003	Period	Uint16	2	WO	0...300 → Period in seconds during which the device lights up. If the device receives the value 0, the function is stopped.	N/A
Function 4: Reset to factory setting / Reset parameter						
60000	Function selection	Uint16	2	WO	4 → Selection of function <i>Reset parameters to factory settings</i>	N/A
60001	Pattern value part 1	Uint16	2	WO	64199 → Safety pattern must be written for the function to be executed	N/A
60002	Pattern value part 2	Uint16	2	WO	1304 → Safety pattern must be written for the function to be executed	N/A
60003	Type of reset to factory setting	Uint16	2	WO	1 → Reset to factory settings including interface parameters 2 → Reset to factory settings excluding interface parameters	N/A
Function 6: Test						
60000	Function selection	Uint16	2	WO	6 → Selection of the <i>Test</i> function	N/A
60001	Pattern value part 1	Uint16	2	WO	32343 → Safety pattern must be written for the function to be executed	N/A
60002	Pattern value part 2	Uint16	2	WO	0 → Safety pattern must be written for the function to be executed	N/A
60003	Type of test	Uint16	2	WO	1 → Start IMD test	N/A

Address (dec)	Register name	Data type	Bytes	Mode	Value / Unit / Comment	Factory setting
Function 7: Reset						
60000	Function selection	Uint16	2	WO	7 → Selection of <i>Reset</i> function	N/A
60001	Pattern value part 1	Uint16	2	WO	13623 → Safety pattern must be written for the function to be executed	N/A
60002	Pattern value part 2	Uint16	2	WO	0 → Safety pattern must be written for the function to be executed	N/A
60003	Type of reset	Uint16	2	WO	1 → Reset of the alarm message when fault memory is enabled	N/A

7 Error – Cause – Error correction

Error pattern	Cause	Correction
Complete device		
No device start	Supply voltage incorrectly connected	Establish correct wiring. Plug in terminal blocks correctly.
RS-485		
Instable communication	Incorrect termination.	Check termination resistors.
	Incorrect bias resistors R_B .	Check or install bias resistors R_B .
No communication	Incorrect configuration: e.g. different baud rates between bus devices, parity, start/stop bits etc.	Set up a uniform configuration for all bus participants.
	Incorrect connection: terminals A and B are interchanged.	Establish correct bus wiring.
Alarm relays		
Relay does not switch	No alarm message due to defective component or defective controlling devices. No alarm source has been assigned.	Check relay for proper function (register 59001), replace device if necessary. Assign alarm sources.
	No alarm reset due to sticking or defective relay. Switching current > 5 A.	Replace device, if necessary. Observe technical data of the switching output.
	No switching of the relay due to excessive preloads on contacts.	Observe technical data of the switching output.
Enclosure		
Broken screw-mounting brackets	Device becomes detached due to broken mounting brackets.	Preventive measure: Use correct screw type and observe max. tightening torque. If the screw-mounting brackets are defective: mount on DIN rail or replace device.
Broken enclosure	Mechanical damage	Do not operate the device for safety reasons.
Terminals		
Wires detach from the terminal	Due to splicing of wire ends, it is not possible to insert them into the terminal or fix them firmly in the terminal.	Use ferrules.
Wires cannot be removed from terminal	Ferrules with strong crimp impressions get stuck in the terminal.	Use suitable crimping pliers.

8 Maintenance

Maintenance and cleanig of the device is not intended.

9 Technical data

9.1 Tabular data

Insulation coordination acc. to IEC 61010-1 and IEC 61010-2-30

Definitions	
Measuring circuit (IC1)	L1/+, L2/-
Supply circuit (IC2)	+, -
Output circuit (IC3)	11, 14, 12
Control circuit (IC4)	FE1, FE2
Control circuit (IC5)	A, B
Pollution degree	2

Definition of circuits according to IEC 61010-1, section 6.7.1.5

IC1	Measuring circuit, CAT III, 600 V
IC2	60 V (Secondary circuit, derived from primary circuit < AC 300 V, OVC II) ¹
IC3	Mains circuit, OVC III, 300 V
IC4 / IC5	≤ 30 V, not dangerously active

Protective separation (reinforced insulation) between the circuits

IC1 / (IC2-IC5)	protective impedance
IC3 / (IC2, IC4-IC5)	

Voltage tests (routine test) according to IEC 61010-1

IC1 / IC4	AC 510 V
IC3 / (IC1, IC2, IC4, IC5)	AC 2.2 kV
IC2 / (IC1, IC4, IC5)	AC 350 V
IC4 / IC5	AC 200 V

¹ Operation with SELV or PELV also possible

Supply voltage

isoGEN413R-1: (+/-)

Supply voltage U_s	DC 12...48 V
Tolerance of U_s	-20...+25 %
Power consumption	≤ 1.1 W
Inrush current (< 5 ms)	< 10 A

Monitored IT system

isoGEN413R-1

Nominal system voltage U_n	3(N)AC, AC, DC 0...400 V
Tolerance of U_n	+15 %
Frequency range of U_n	42...460 Hz

Measuring circuit

Measuring voltage U_m	± 16 V
Measuring current I_m at $R_F, Z_F = 0 \Omega$	$\leq 90 \mu\text{A}$
Internal resistance R_i, Z_i	$\geq 178 \text{ k}\Omega$
Permissible system leakage capacitance C_e	$\leq 5 \mu\text{F}$
Permissible extraneous DC voltage U_{fg}	≤ 650 V

Response values

Response value R_{an1}	10...250 k Ω (46 k Ω)*
Response value R_{an2}	5...200 k Ω (23 k Ω)*
Relative uncertainty R_{an}	± 15 %, ± 3 k Ω
Hysteresis R_{an}	25 %, minimum 1 k Ω

Time response

Relative uncertainty t_{an} at $R_F = 0,5 \times R_{an}$ and $C_e = 1 \mu\text{F}$ acc. to VDE 0100-551	≤ 1 s
Start-up delay t^1	0...1800 s (0 s)*
Response delay t_{on}^1	0...1800 s (0 s)*
Delay on release t_{off}^1	0...1800 s (0 s)*
Recovery time	< 5 s

1 Can be parameterised via Bender Connect app and Modbus

Displays, memory

Display	Status LED incl. LED bargraph (7 LEDs)
Display range insulation resistance (R_F)	1...1000 k Ω
Measuring range insulation resistance (R_F) ¹	1...10000 k Ω
Operating uncertainty	± 15 % ± 3 k Ω
Fault memory alarm messages ²	on/off (off)*

1 Step size: 1 k Ω

2 Can be parameterised via Bender Connect app and Modbus

RS-485 interface

Protocol	Modbus RTU
Baud rate ¹	max. 115.2 kbit/s (19.2 kbit/s)* max. 9.6 kbit/s for 1200 m cable length
Parity ¹	even, no, odd (even)*
Stop bits ¹	1 / 2 / auto (auto)*
Device address, Modbus RTU ²	1...247 (100 + SN)*
Cable length	≤ 1200 m
Cable type	CAT6/CAT7 recommended; min. J-Y(St)Y 2 × 0.6wisted pair; shield connected to PE on one side
Termination resistor (external)	120 Ω (0.25 W)

1 Can be parameterised via Bender Connect app and Modbus

2 Factory setting: 100 + last two digits of serial number

Switching elements

Switching elements	1 changeover contact
Operating principle ¹	n/c / n/o (n/c)*
Electrical endurance	10,000 cycles

1 Can be parameterised via Bender Connect app and Modbus

Contact data acc. to IEC 60947-5-1

Utilisation category	AC-12 / AC-14 / DC-12 / DC-12 / DC-12
Rated op. voltage	250 V / 250 V / 24 V / 110 V / 220 V
Rated op. current	5 A / 2 A / 1 A / 0.2 A / 0.1 A
Minimum contact rating ¹	10 mA at AC/DC ≥ 10 V

1 refers to relays that have not been operated with high contact currents

Connection

iso415R-1

Connection type	Push-in plug connector
Nominal current	≤ 5 A
Stripping length	8...9 mm

Connection properties for grid dimension 3.5 mm

rigid	0.2...1.5 mm ² (AWG 24...16)
flexible	0.2...1.5 mm ² (AWG 24...16)
with ferrule with plastic sleeve	0.25...0.5 mm ²
with ferrule without plastic sleeve	0.25...1.5 mm ²

Connection properties for grid dimension 5.08 mm (relay switching contacts)

rigid	0.2...1.5 mm ² (AWG 24...16)
flexible	0.2...1.5 mm ² (AWG 24...16)
with ferrule with plastic sleeve	0.25...1.5 mm ²
with ferrule without plastic sleeve	0.25...1.5 mm ²

Environment/EMC

EMC	IEC 61326-2-4
Operating altitude	≤ 2000 AMSL

Ambient temperatures

Operation	-25...+55 °C
Transport	-40...+85 °C
Storage	-40...+70 °C

Climatic conditions acc. to IEC 60721 (related to temperature and relative humidity)

Stationary use (IEC 60721-3-3)	3K22
Transport (IEC 60721-3-2)	2K11
Long-term storage (IEC 60721-3-1)	1K22

Mechanical conditions acc. to IEC 60721

Stationary use (IEC 60721-3-3)	3M11
Transport (IEC 60721-3-2)	2M4
Long-term storage (IEC 60721-3-1)	1M12

Other

Operating mode	continuous operation
Mounting	cooling slots must be ventilated vertically
Degree of protection, internal components (DIN EN 60529)	IP20
Degree of protection, terminals (DIN EN 60529)	IP20
Enclosure material	polycarbonate

DIN rail mounting acc. to	IEC 60715
Flammability class	UL 94 V-0
Weight	≤ 100 g

()* Factory setting

9.2 Standards and certificates

Standards

The isoGEN413R-1 has been developed in accordance with the following standards:

- IEC 61557-8
- DIN VDE 0100-551

Licences

For a list of the open-source software used see our [Website](#).

Declaration of conformity

Bender GmbH & Co. KG hereby declares that the device covered by the Radio Equipment Directive complies with Directive 2014/53/EU.

The complete EU and UK declarations of conformity are available in the download area:

<https://www.bender.de/en/service-support/download-area/>

Marks



9.3 Ordering information

Type	Supply voltage U_s	Nominal system voltage U_n	Art. No.
isoGEN413R-1	DC 12...48 V	3(N)AC, AC, DC 0...400 V	B81674000

Accessories

Description	Art. No.
SMARTDETECT ISO41xR connector kit for push-in terminals	B80609102
SMARTDETECT 41x Sealable transparent cover 49 × 18 × 3 (mm)	B80609199

9.4 Document revision history

Date	Document version	State/Changes
02.2026	00	First issue
05.2026	01	Changed <ul style="list-style-type: none"> • Degree of protection, internal components: IP20



Bender GmbH & Co. KG

Londorfer Straße 65
35305 Grünberg
Germany

Tel.: +49 6401 807-0
info@bender.de
www.bender.de

All rights reserved.
Reprinting and duplicating only with
permission of the publisher.



© Bender GmbH & Co. KG, Germany
Subject to change!
The specified standards take into
account the edition valid until 05.2026
unless otherwise indicated.